

## Features

- 10A switching capability
- Low height, only 12.5 mm
- The creepage distance between the coil and the contact with a dielectric withstanding voltage of 4kV is more than 8mm
- Products conforming to IEC60335-1 standard are available
- Various contact types are available
- A variety of sockets are available
- UL insulation system:Class F
- Through-hole reflow specification products are available
- Outline Dimensions:(28.6×10.3×12.3)mm



## CHARACTERISTICS

Specifications	Item		
Contact Data	Contact arrangement		1A, 1B, 1C
	Contact resistance(initial)		≤100mΩ(6VDC 1A)
	Contact material		AgNi, AgSnO <sub>2</sub>
Rated value	Rated load(Resistance load)		10A 250VAC
	Max.switching voltage		440VAC
	Max.switching current		10A
	Max.switching capacity		2500VA
	Min.allowing load		5VDC 100mA
Electrical performance	Insulation resistance(initial)		1000MΩ(500VDC)
	Dielectric strength (initial)	Between open contacts	1000VAC, 1 min
		Between coil&contacts	5000VAC, 1 min
	Operate time		≤10ms
	Release time		≤5ms
Mechanical performance	Shock resistance	Functional	98m/s <sup>2</sup> (10G)
		Destructive	980m/s <sup>2</sup> (100G)
	Vibration resistance		10Hz~55Hz 1.5mm DA
Endurance	Mechanical		1×10 <sup>7</sup> ops
	Electrical(Room temperature)		10A 250VAC 1×10 <sup>5</sup> ops(ON/OFF=1s/9s)
Operate condition	Ambient temperature		-40℃~85℃
	Humidity		5% to 90%
Termination			PCB
Unit weight			Approx.8g
Construction			Plastic sealed, Flux proofed

## ■ COIL DATA(23°C)

Nominal Voltage	Operate Voltage VDC	Release Voltage VDC	Rated Current ( $\pm 10\%$ )	Coil Resistance ( $\pm 10\%$ )	Nominal Power	Max Voltage
DC 5V	$\leq 3.75$	$\geq 0.25$	50mA	100 $\Omega$	250mW	DC 6.5V
DC 6V	$\leq 4.50$	$\geq 0.30$	41.7mA	144 $\Omega$		DC 7.8V
DC 9V	$\leq 6.75$	$\geq 0.45$	27.8mA	324 $\Omega$		DC 11.7V
DC 12V	$\leq 9.00$	$\geq 0.60$	20.8mA	576 $\Omega$		DC 15.6V
DC 18V	$\leq 13.50$	$\geq 0.90$	13.9mA	1296 $\Omega$		DC 23.4V
DC 24V	$\leq 18.00$	$\geq 1.20$	10.4mA	2304 $\Omega$		DC 31.2V
DC 48V	$\leq 36.00$	$\geq 2.40$	6.3mA	7680 $\Omega$	300mW	DC 62.4V
DC 60V	$\leq 45.00$	$\geq 3.00$	5.0mA	12000 $\Omega$		DC 78.0V

## ■ ORDERING INFORMATION

**FH48 -1A 1 S T -XXX DC12V**

- ① Type
- ② Contact arrangement(1):1A=1 open contacts, 1B=1 close contacts, 1C=1 switched contacts
- ③ PCB mounting:1=type 1, 2=type 2, 3=type 3
- ④ Construction(2):Nil=Flux proofed, S=Plastic sealed
- ⑤ Contact material (3):Nil=AgNi, T=AgSnO<sub>2</sub>
- ⑥ Customer special code:numbers or letters denote customer's requirements
- ⑦ Coil specification:DC5/6/9/12/18/24/48/60V

- (1) If need the contact arrangement is 1B, please contact with the salesman to ask for the outline dimensions, wiring diagram and PC board layout.
- (2) When used in clean environment(excluding H<sub>2</sub>S, SO<sub>2</sub>, NO<sub>2</sub>, dust and other pollutants), it is recommended to choose the Flux proofed type; When used in unclean environment(contain H<sub>2</sub>S, SO<sub>2</sub>, NO<sub>2</sub>, dust and other pollutants), it is recommended to choose the Plastic sealed.
- (3) Due to the high surge current of relay connection, we propose to use AgSnO<sub>2</sub> contacts.

## ■ OUTLINE DIMENSIONS, WIRING DIAGRAM AND PC BOARD LAYOUT(Unit:mm)

**1A1**

Outline Dimensions

Wiring Diagram  
(Bottom view)

PCB Layout  
(Bottom view)

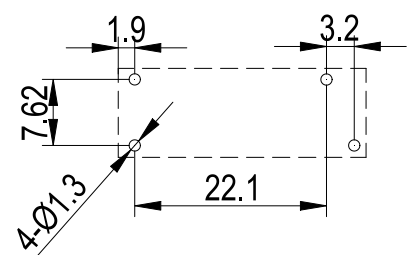
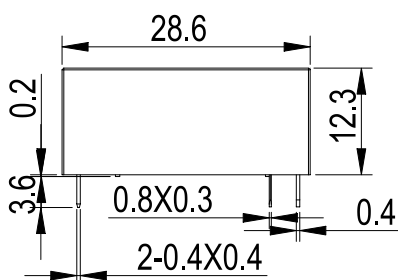

# OUTLINE DIMENSIONS, WIRING DIAGRAM AND PC BOARD LAYOUT (Unit:mm)

1A2

Outline Dimensions

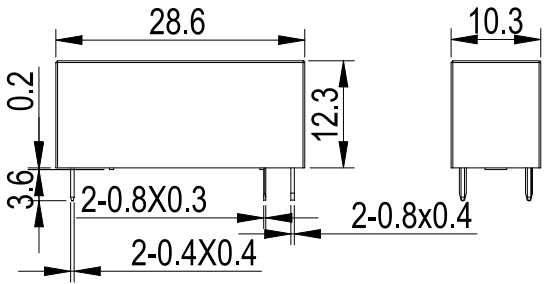

Wiring Diagram  
(Bottom view)

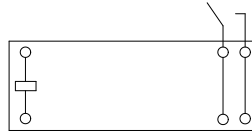

PCB Layout  
(Bottom view)

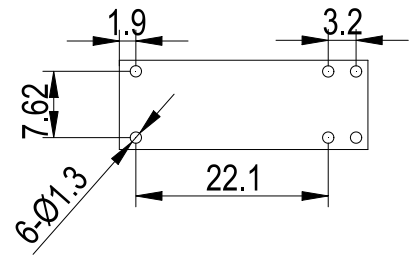

1A3

Outline Dimensions

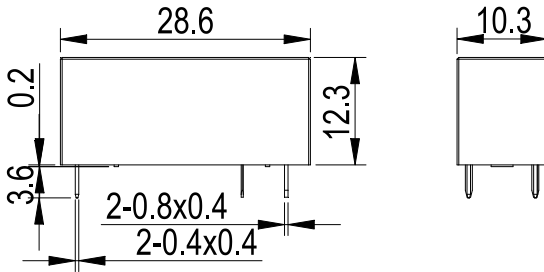

Wiring Diagram  
(Bottom view)



PCB Layout  
(Bottom view)

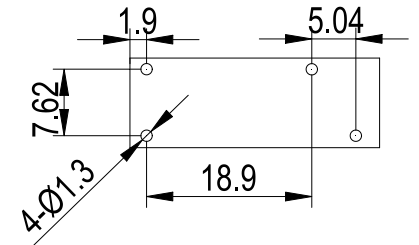

1B3

Outline Dimensions

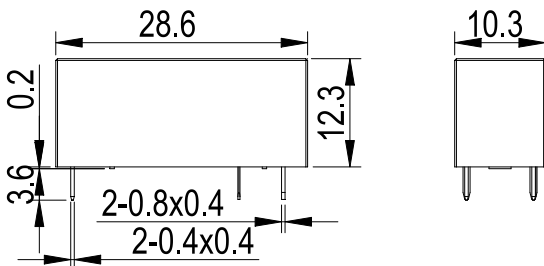

Wiring Diagram  
(Bottom view)



PCB Layout  
(Bottom view)

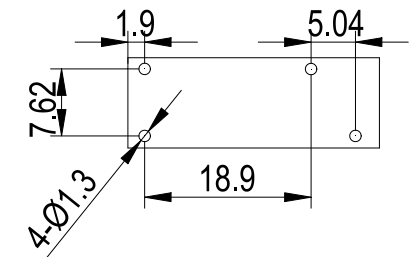

1C1

Outline Dimensions

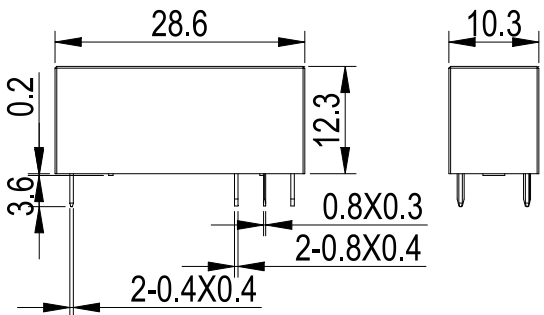

Wiring Diagram  
(Bottom view)



PCB Layout  
(Bottom view)

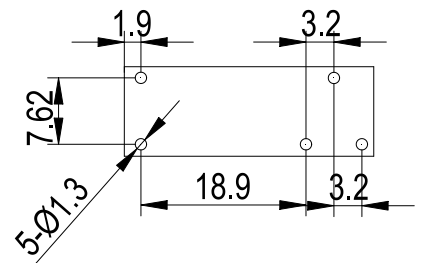

## ■ OUTLINE DIMENSIONS, WIRING DIAGRAM AND PC BOARD LAYOUT (Unit:mm)

1C2

Outline Dimensions

Wiring Diagram  
(Bottom view)

PCB Layout  
(Bottom view)

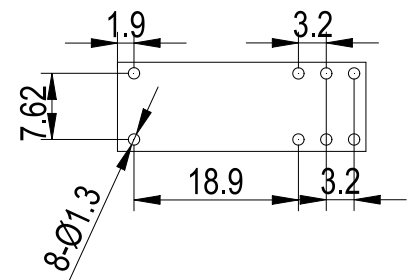
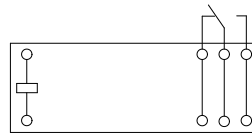
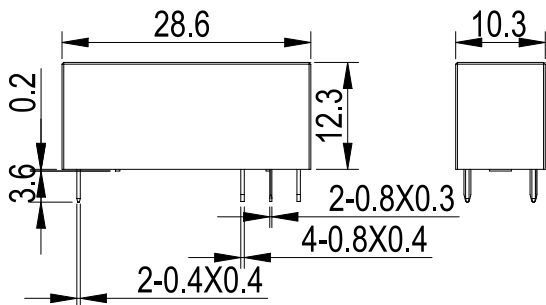

Remark: (1) In case of no tolerance shown in outline dimension: outline dimension  $\leq 1$ mm, tolerance should be  $\pm 0.2$ mm; outline dimension  $> 1$ mm and  $< 5$ mm, tolerance should be  $\pm 0.3$ mm; outline dimension  $\geq 5$ mm, tolerance should be  $\pm 0.5$ mm.

(2) The tolerance without indicating for PCB layout is always  $\pm 0.1$ mm.

## ■ SAFETY APPROVAL RATINGS

Approval	File No.	Contact arrangement	Contact material	Approved ratings		
UL/C-UL	E475405	1A、1C(NO)	AgNi、AgSnO <sub>2</sub>	8/10A	277/250/240/125/120VDC	85°C
		1B、1C(NC)	AgNi、AgSnO <sub>2</sub>	8/10A	277/250/240/125/120VDC	85°C
TUV	Under certification	1A、1C(NO)	AgNi、AgSnO <sub>2</sub>	8/10A	277/250/240/125/120VDC	85°C
		1B、1C(NC)	AgNi、AgSnO <sub>2</sub>	8/10A	277/250/240/125/120VDC	85°C
CQC	CQC23002412542	1A、1C(NO)	AgNi、AgSnO <sub>2</sub>	8/10A	277/250VDC	85°C
		1B、1C(NC)	AgNi、AgSnO <sub>2</sub>	8/10A	277/250VDC	85°C

## ■ PERFORMANCE CURVES

### MAXIMUM SWITCHING POWER

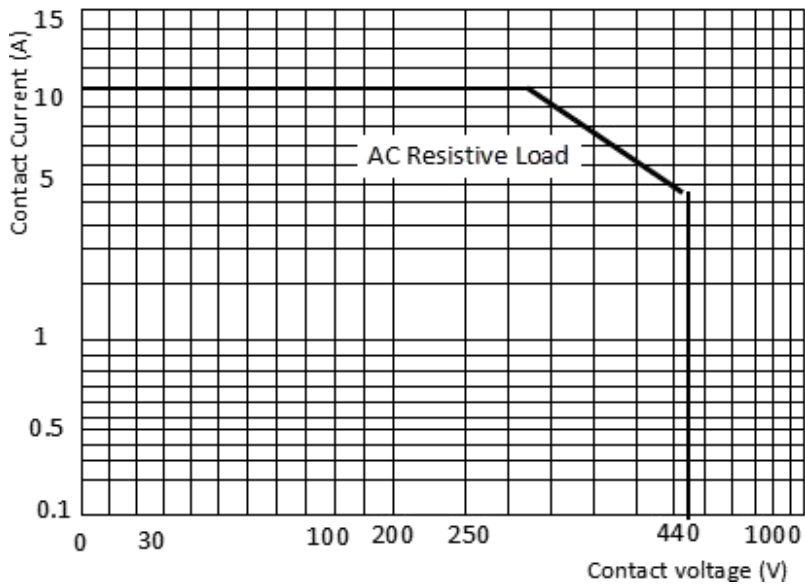

### ENDURANCE CURVE

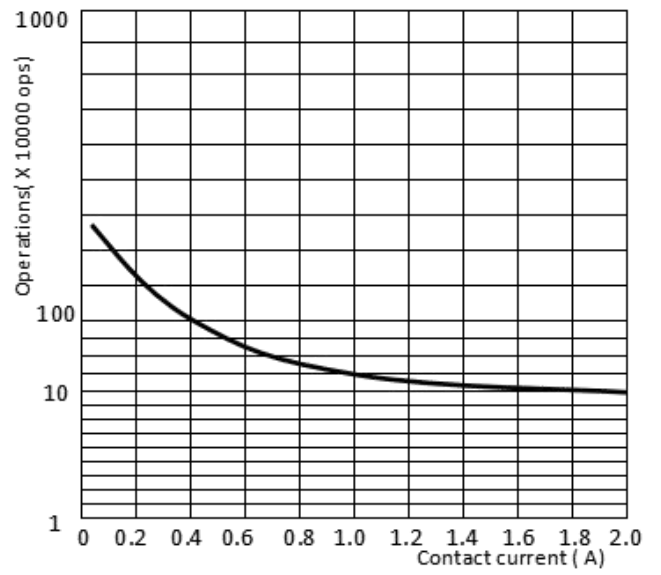

## ■ NOTICE

- ① In order to maintain the initial performance parameters of the relay, please be careful not to drop the product;
- ② The specification is for reference only. Specifications subject to change without notice.